

12

FRAMES AND DOORS
RAHMEN UND TÜREN
CADRES ET PORTES

MARCOS PUERTAS

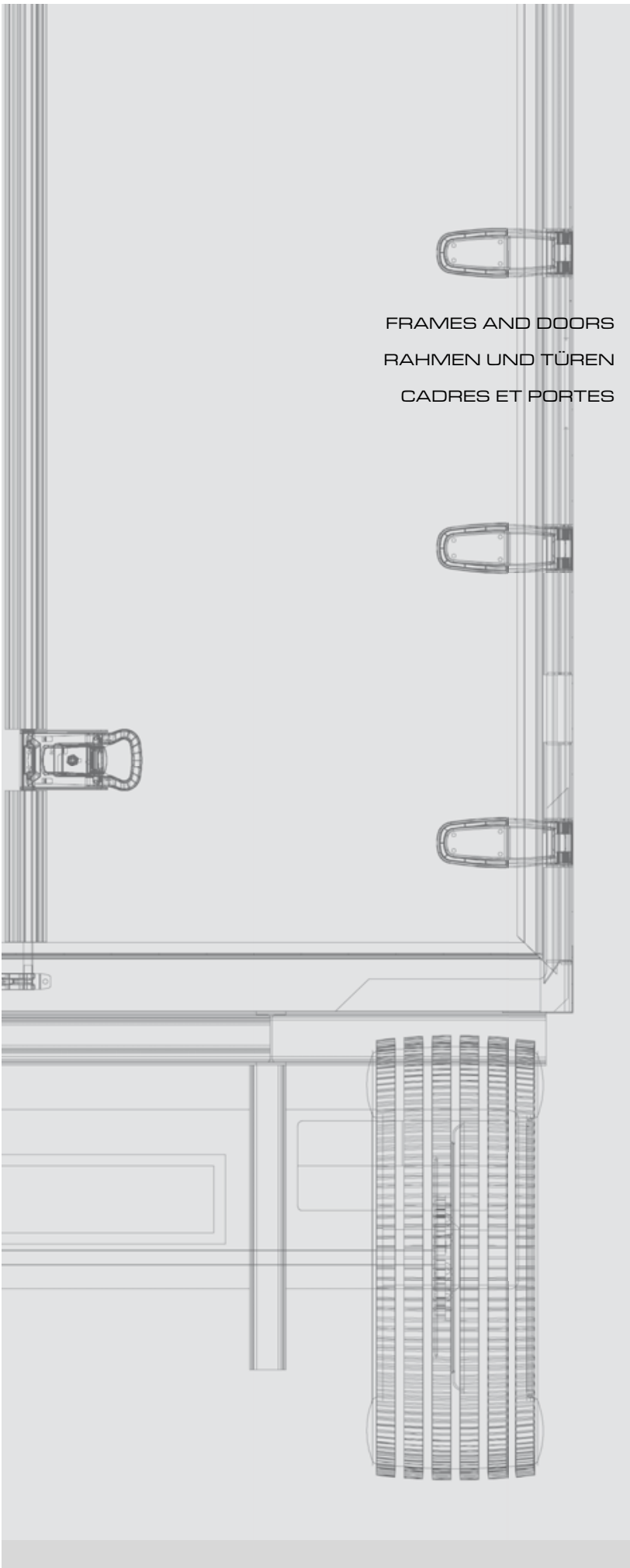

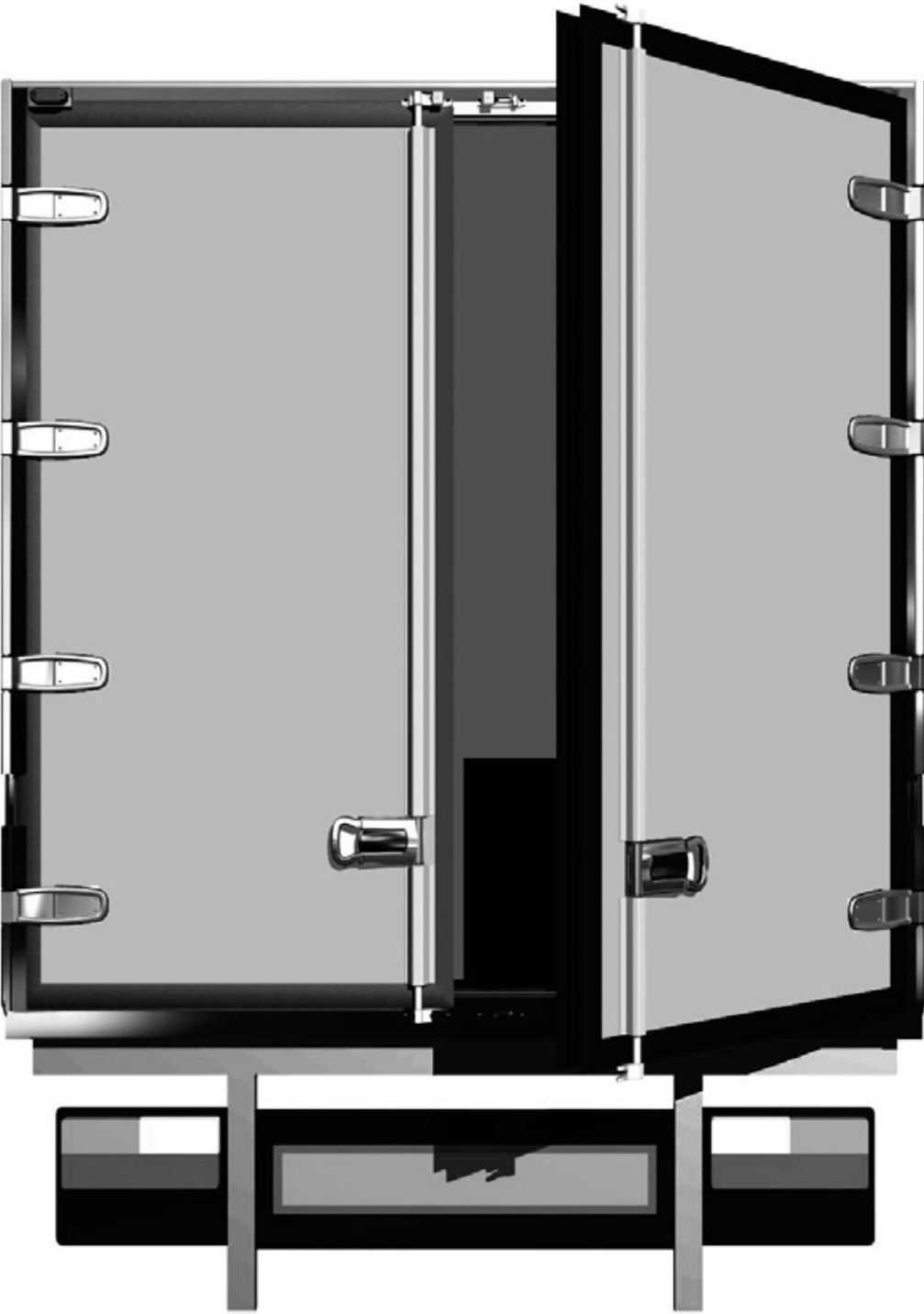

MARCOS Y PUERTAS

FRAMES AND DOORS RAHMEN UND TÜREN CADRES ET PORTES

12.1

MARCO TRASERO LISO 2 | Rear frame 2 | Glatte Rahmen 2 | Cadre lisse 2 |

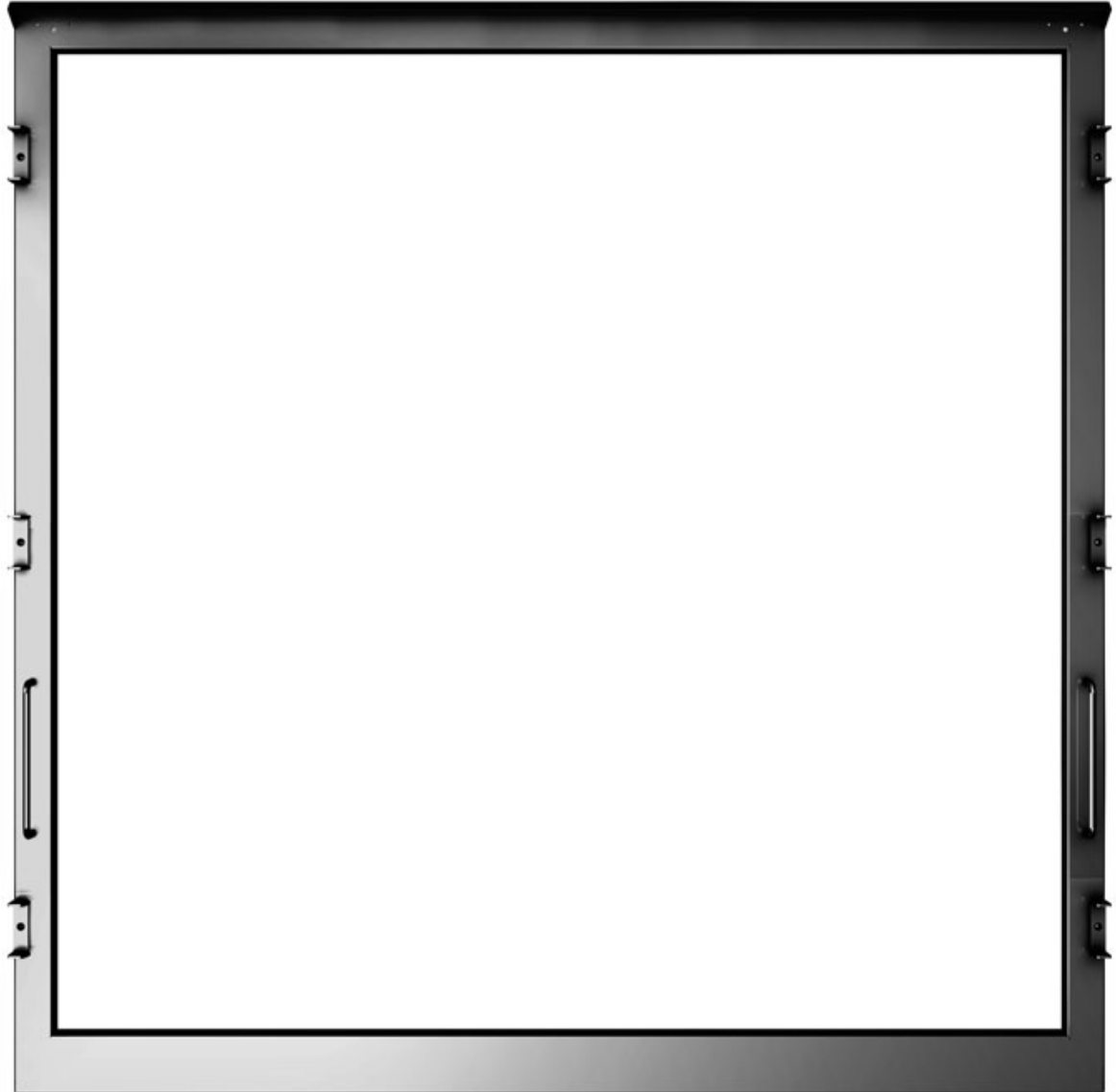

MARCOS Y PUERTAS

FRAMES AND DOORS RAHMEN UND TÜREN CADRES ET PORTES

12.2

MARCO TRASERO LISO 3 | Rear frame liso 3 | Glatte Rahmen 3 | Cadre lisse 3 |

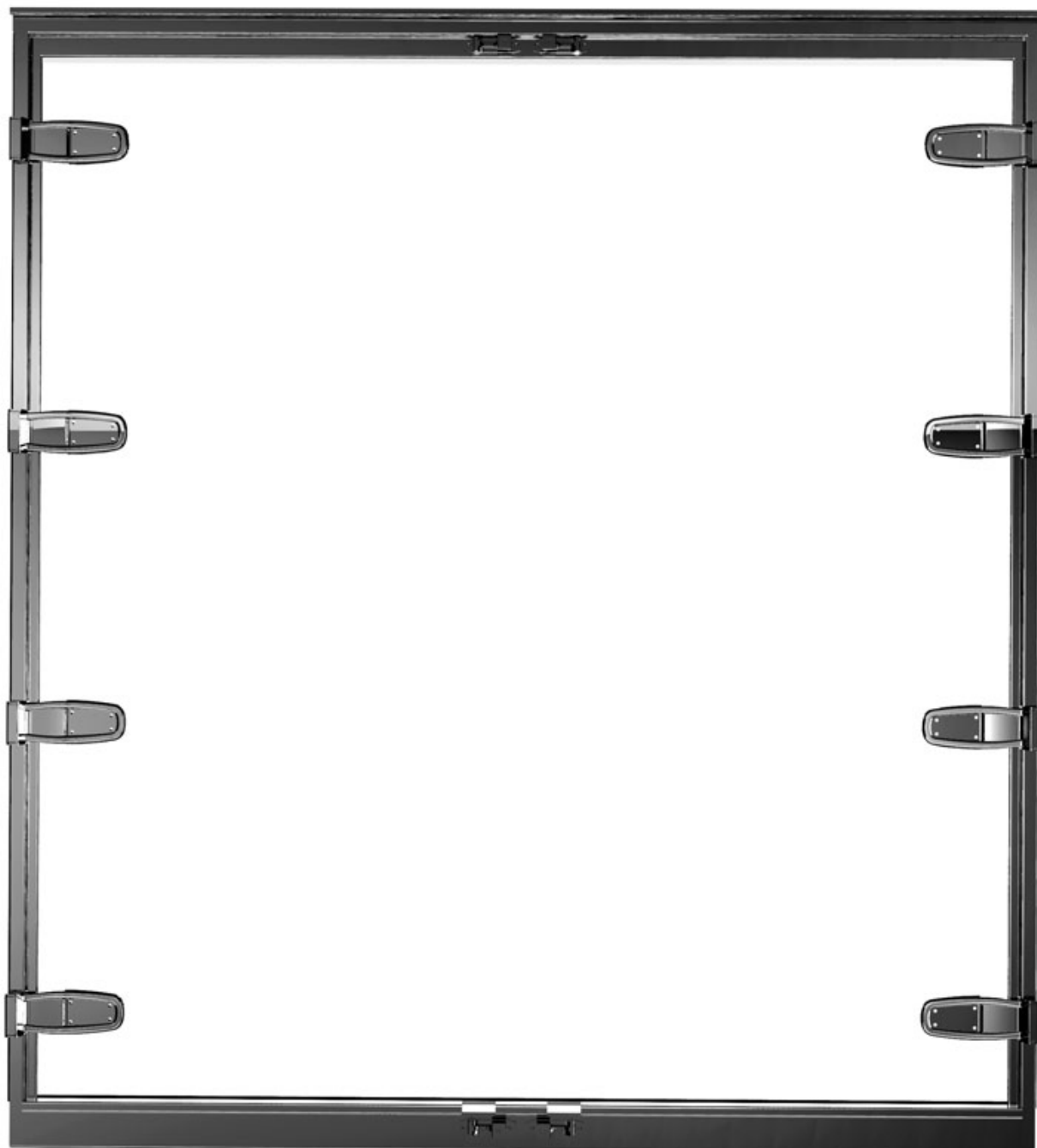

MARCOS Y PUERTAS

FRAMES AND DOORS RAHMEN UND TÜREN CADRES ET PORTES

12.3

MARCO TRASERO CF3 CV DF3 | Rear frame CF3 CV DF3 | Heckrahmen CF3CVDF3 | Cadre arrière CF3 CV DF3 |

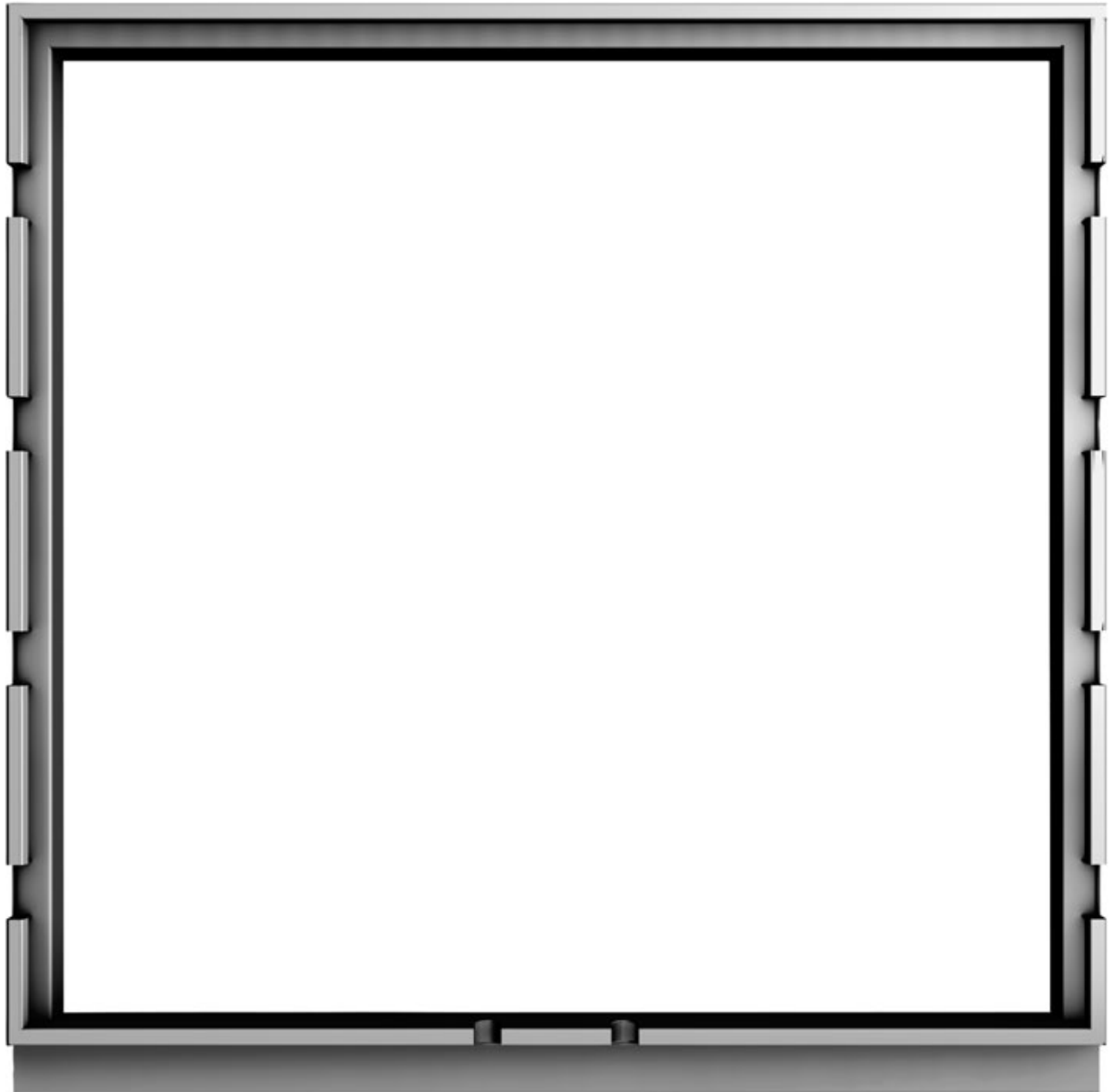

MARCOS Y PUERTAS

FRAMES AND DOORS RAHMEN UND TÜREN CADRES ET PORTES

12.4

MARCO TRASERO CF2 CV DF3 | Rear frame CF2 CV DF3 | Heckrahmen CF2CVDF3 | Cadre arrière CF2 CV DF3 |

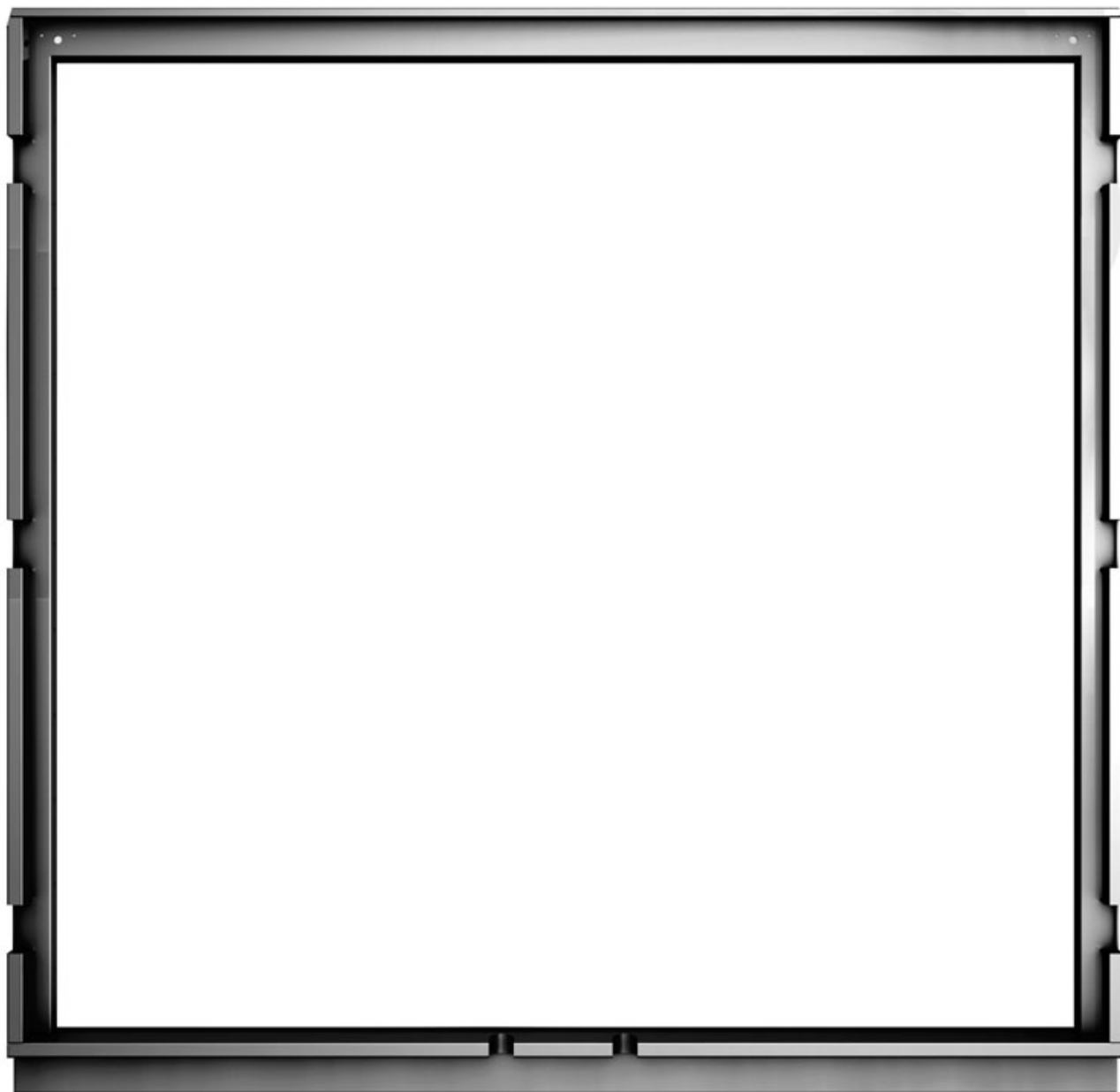

MARCOS Y PUERTAS

FRAMES AND DOORS RAHMEN UND TÜREN CADRES ET PORTES

12.5

MARCO TRASERO ESQUINAS ESFÉRICAS | Rear frame | Heckrahmen mit sphärischen Ecken | Cadre Paneltex à coins sphériques |

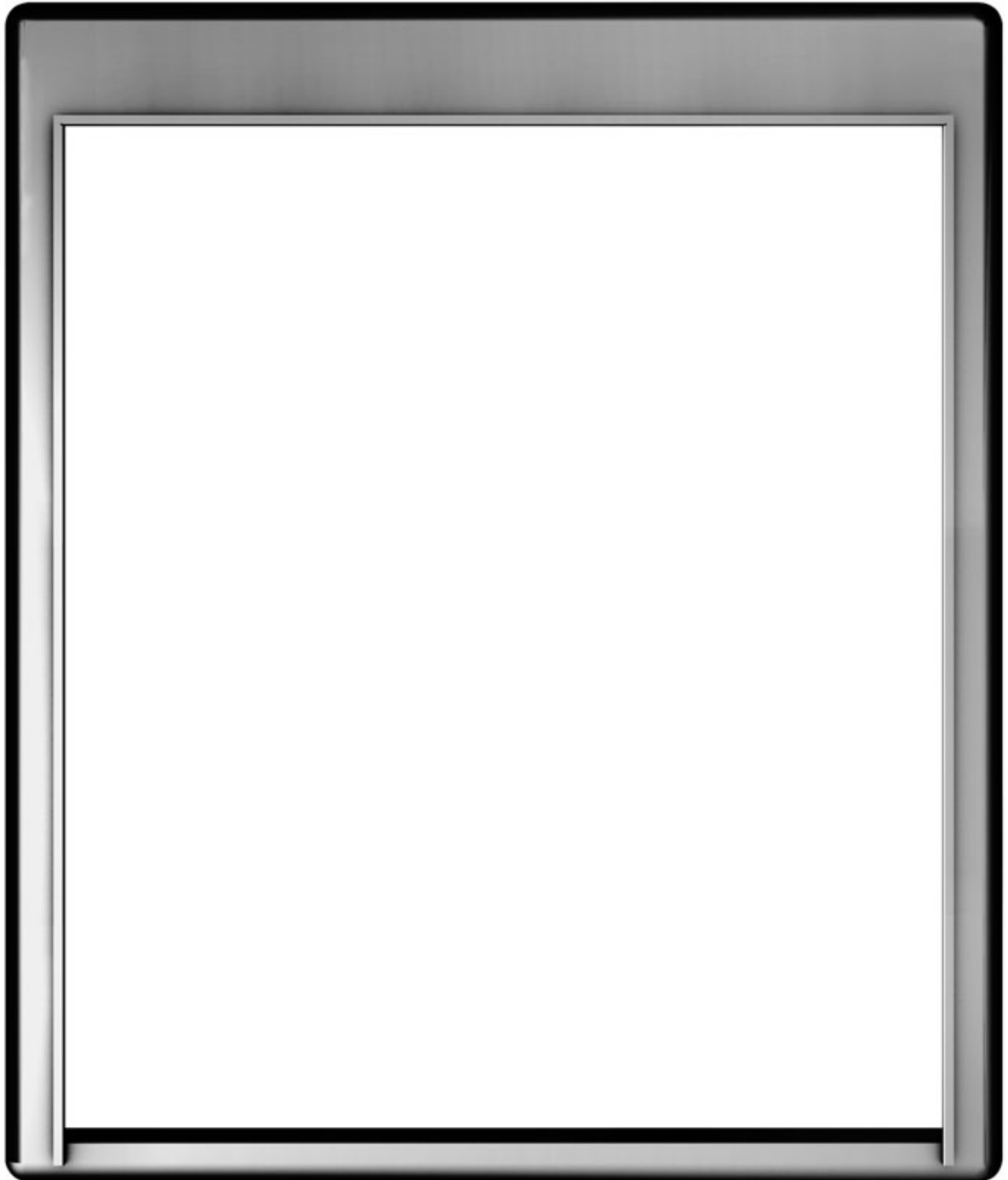

MARCOS Y PUERTAS

FRAMES AND DOORS RAHMEN UND TÜREN CADRES ET PORTES

12.6

MARCO LATERAL | Side frame | Seitentürrahmen | Cadre latéral |

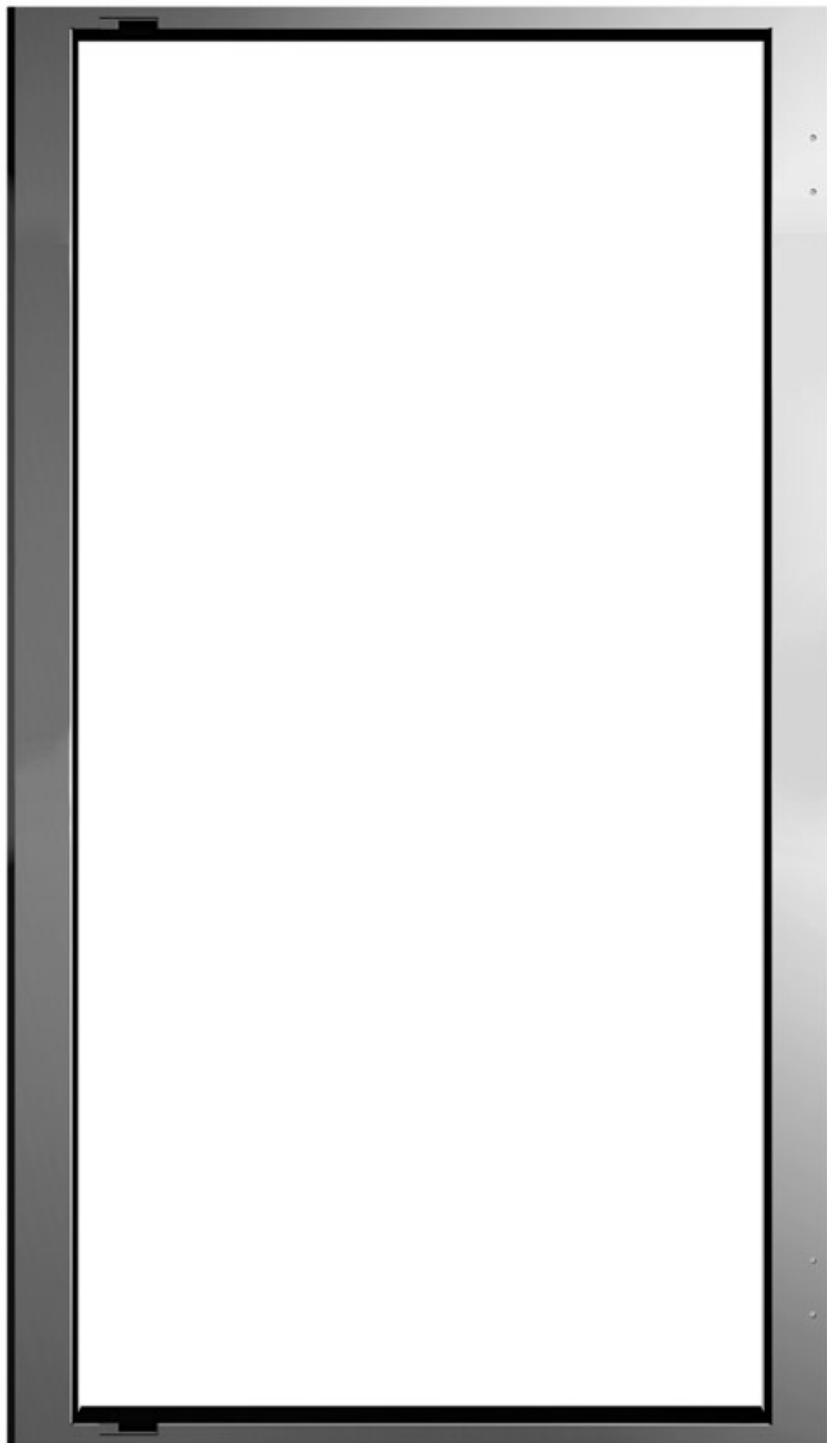

MARCOS Y PUERTAS

FRAMES AND DOORS RAHMEN UND TÜREN CADRES ET PORTES

12.7

PEDIDO PARA MARCOS

S/PEDIDO:	EMPRESA:	
FECHA:	P/CONTACTO:	
N/PEDIDO:	HOJA N°1	

DIMENSIONES GENERALES DEL MARCO

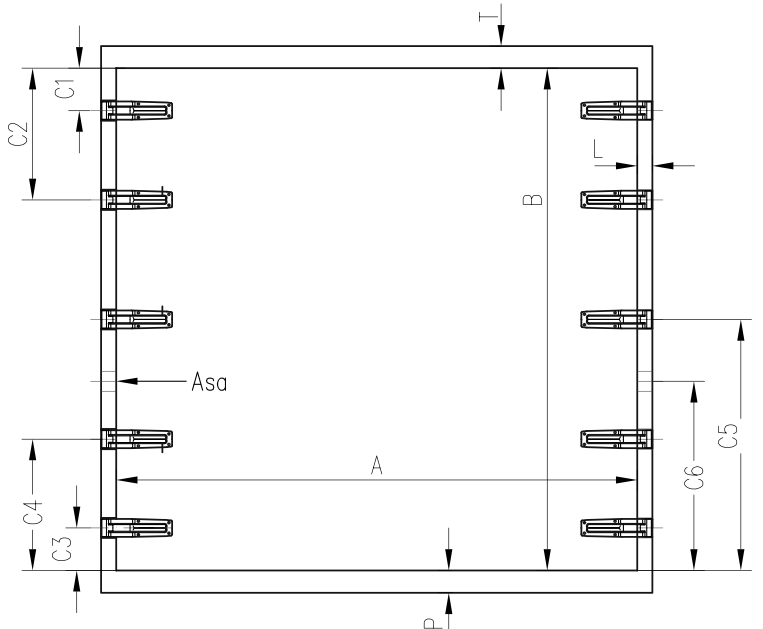

*A=
*B=
C1=
C2=
C3=
*L=
*T=
*P=
REF/BISAGRA:

C4=
C5=
 ASAS (x2)
C6=

N° DE BISAGRAS/PUERTA
 2 5
 3 6
 4

* SIEMPRE MEDIDAS DE LA CAJA DEL CAMION

CARACTERISTICAS DE LOS PERFILES

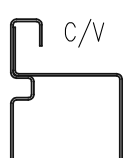
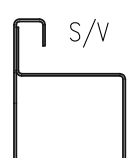
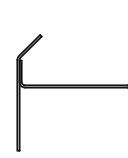
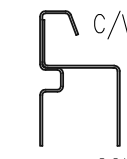
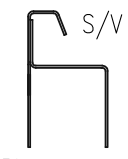
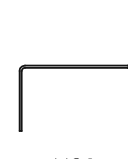
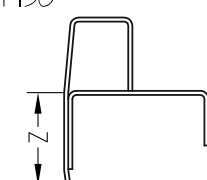
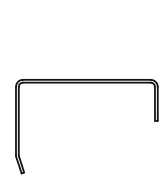
<p>TECHO</p> <div style="display: flex; justify-content: space-around;"> <div style="text-align: center;">  C/V CON FORMA </div> <div style="text-align: center;">  S/V CON FORMA </div> <div style="text-align: center;">  LISO </div> </div>	<p>ESPELOR DE CHAPA: <input type="checkbox"/> 2mm <input type="checkbox"/> 3mm</p> <p><input type="checkbox"/> CON FORMA <input type="checkbox"/> C/V <input type="checkbox"/> S/V</p> <p><input type="checkbox"/> LISO</p> <p><input type="checkbox"/> LUZ DE GALIBO**</p> <p><input type="checkbox"/> 3° LUZ DE FRENO</p> <p><input type="checkbox"/> TALADROS CARA EXTERIOR ø6.5 mm <input type="checkbox"/> AVELLANADO</p> <p><input type="checkbox"/> TALADROS CARA INTERIOR ø6.5 mm <input type="checkbox"/> AVELLANADO</p> <p style="text-align: right;">**CUMPLIMENTAR HOJA N°2</p>
<p>LATERALES</p> <div style="display: flex; justify-content: space-around;"> <div style="text-align: center;">  C/V CON FORMA </div> <div style="text-align: center;">  S/V CON FORMA </div> <div style="text-align: center;">  LISO </div> </div>	<p>ESPELOR DE CHAPA: <input type="checkbox"/> 2mm <input type="checkbox"/> 3mm</p> <p><input type="checkbox"/> CON FORMA <input type="checkbox"/> C/V <input type="checkbox"/> S/V</p> <p><input type="checkbox"/> LISO</p> <p><input type="checkbox"/> TALADROS CARA EXTERIOR ø6.5 mm <input type="checkbox"/> AVELLANADO</p> <p><input type="checkbox"/> TALADROS CARA INTERIOR ø6.5 mm <input type="checkbox"/> AVELLANADO</p>
<p>PISO</p> <div style="display: flex; justify-content: space-around;"> <div style="text-align: center;">  CON FORMA </div> <div style="text-align: center;">  LISO </div> </div>	<p>ESPELOR DE CHAPA: <input type="checkbox"/> 2mm <input type="checkbox"/> 3mm</p> <p><input type="checkbox"/> CON FORMA</p> <p><input type="checkbox"/> LISO</p> <p><input type="checkbox"/> TALADROS CARA EXTERIOR ø6.5 mm <input type="checkbox"/> AVELLANADO</p> <p><input type="checkbox"/> TALADROS CARA INTERIOR ø6.5 mm <input type="checkbox"/> AVELLANADO</p> <p><input type="checkbox"/> ENTALLADURAS PARA CREMONAS**</p> <p>Z (LONGITUD ENTRANTE LARGO)=</p> <p>**CUMPLIMENTAR HOJA N°2 (SOLO DEFENSA CON FORMA)</p>

MARCOS Y PUERTAS

FRAMES AND DOORS RAHMEN UND TÜREN CADRES ET PORTES

12.8

PEDIDO PARA MARCOS

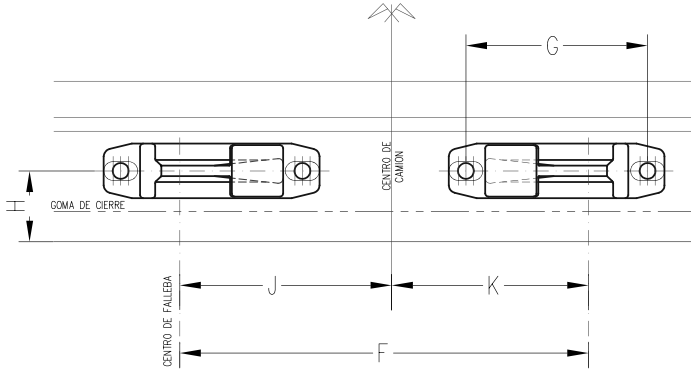
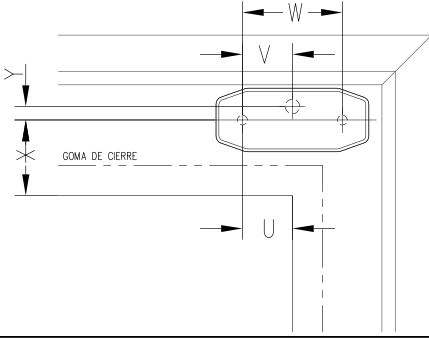
S/PEDIDO:	EMPRESA:	 <p>MECANIZADOS RODRIGUEZ FERNANDEZ</p>
FECHA:	P/CONTACTO:	
N/PEDIDO:	HOJA N°2	
CREMONAS Y CENTROS DE FALLEBAS		
 <div style="float: right; margin-top: 10px;"> <p>*F=</p> <p>G=</p> <p>H=</p> <p>*J=</p> <p>*K=</p> <p><small>*NECESARIAS PARA ENTALLADURAS EN LA DEFENSA CON FORMA</small></p> </div>		
LUCES DE GALIBO		
<p>U=</p> <p>V=</p> <p>W=</p> <p>X=</p> <p>Y=</p> <p>TALADRO PASACABLES $\phi 12,5$</p> <p>TALADROS PARA TORNILLOS $\phi 5$</p>		
REFUERZOS		
MATERIAL ESTANDAR: ACERO AL CARBONO DD11 6mm		
<input type="checkbox"/> TODO REFORZADO <input type="checkbox"/> REFUERZO PARA CREMONAS SUPERIORES <input type="checkbox"/> REFUERZO PARA CREMONAS INFERIORES <input type="checkbox"/> REFUERZOS EN ESQUINAS		
OBSERVACIONES:		
<hr/> <hr/> <hr/> <hr/> <hr/> <hr/> <hr/> <hr/> <hr/> <hr/>		

MARCOS Y PUERTAS

FRAMES AND DOORS RAHMEN UND TÜREN CADRES ET PORTES

12.9

REAR FRAME

YOUR ORDER:	COMPANY:	
DATE:	CONTACT:	
ORDER NUMBER:	PAGE N° 1	

OVERALL FRAME DIMENSIONS

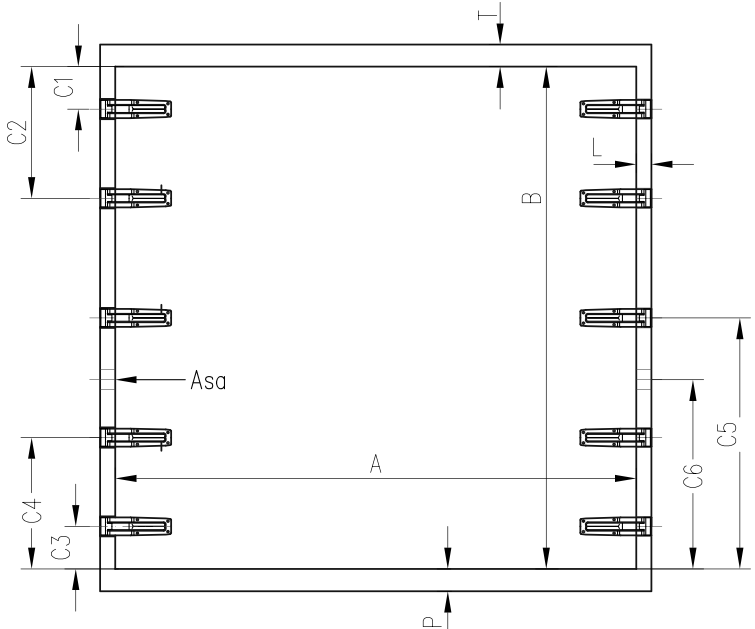





*A=
*B=
C1=
C2=
C3=
*L=
*T=
*P=
Code hinges:

C4=
C5=
 Handle (x2)
C6=

Hinges per door:
 2 5
 3 6
 4

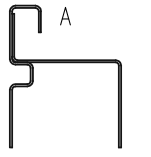
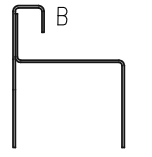
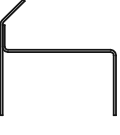
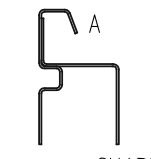
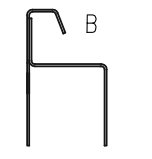
* Truck box dimensions

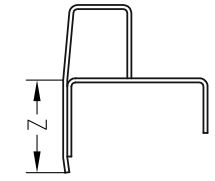
SECTION SPECIFICATIONS

<p>TOP SECTION</p> <div style="display: flex; justify-content: space-around;"> <div style="text-align: center;">  A SHAPED </div> <div style="text-align: center;">  B SHAPED </div> <div style="text-align: center;">  FLAT </div> </div>	<p>MATERIAL THICK: <input type="checkbox"/> 2mm <input type="checkbox"/> 3mm</p> <p><input type="checkbox"/> SHAPED <input type="checkbox"/> A <input type="checkbox"/> B</p> <p><input type="checkbox"/> FLAT</p> <p><input type="checkbox"/> CLEARANCE LIGHTS** **FILL IN PAGE N°2</p> <p><input type="checkbox"/> 3° STOP LIGHT</p> <p><input type="checkbox"/> EXTERNAL HOLES ϕ6.5 mm <input type="checkbox"/> COUNTERSUNK</p> <p><input type="checkbox"/> INTERNAL HOLES ϕ6.5 mm <input type="checkbox"/> COUNTERSUNK</p>
<p>WALL SECTIONS</p> <div style="display: flex; justify-content: space-around;"> <div style="text-align: center;">  A SHAPED </div> <div style="text-align: center;">  B SHAPED </div> <div style="text-align: center;">  FLAT </div> </div>	<p>MATERIAL THICK: <input type="checkbox"/> 2mm <input type="checkbox"/> 3mm</p> <p><input type="checkbox"/> SHAPED <input type="checkbox"/> A <input type="checkbox"/> B</p> <p><input type="checkbox"/> FLAT</p> <p><input type="checkbox"/> EXTERNAL HOLES ϕ6.5 mm <input type="checkbox"/> COUNTERSUNK</p> <p><input type="checkbox"/> INTERNAL HOLES ϕ6.5 mm <input type="checkbox"/> COUNTERSUNK</p>
<p>BOTTOM SECTION</p> <div style="display: flex; justify-content: space-around;"> <div style="text-align: center;">  Z SHAPED </div> <div style="text-align: center;">  FLAT </div> </div>	<p>MATERIAL THICK: <input type="checkbox"/> 2mm <input type="checkbox"/> 3mm</p> <p><input type="checkbox"/> SHAPED</p> <p><input type="checkbox"/> FLAT</p> <p><input type="checkbox"/> EXTERNAL HOLES ϕ6.5 mm <input type="checkbox"/> COUNTERSUNK</p> <p><input type="checkbox"/> INTERNAL HOLES ϕ6.5 mm <input type="checkbox"/> COUNTERSUNK</p> <p><input type="checkbox"/> HOLES FOR KEEPERS**</p> <p>Z)=</p> <p>**FILL IN PAGE N°2 (WHEN SHAPED BOTTOM SECTION)</p>

MARCOS Y PUERTAS

FRAMES AND DOORS RAHMEN UND TÜREN CADRES ET PORTES

12.10

REAR FRAME

YOUR ORDER:	COMPANY:	PAGE N°2	
DATE:	CONTACT:		
ORDER:			

KEEPERS AND LOCK CENTER

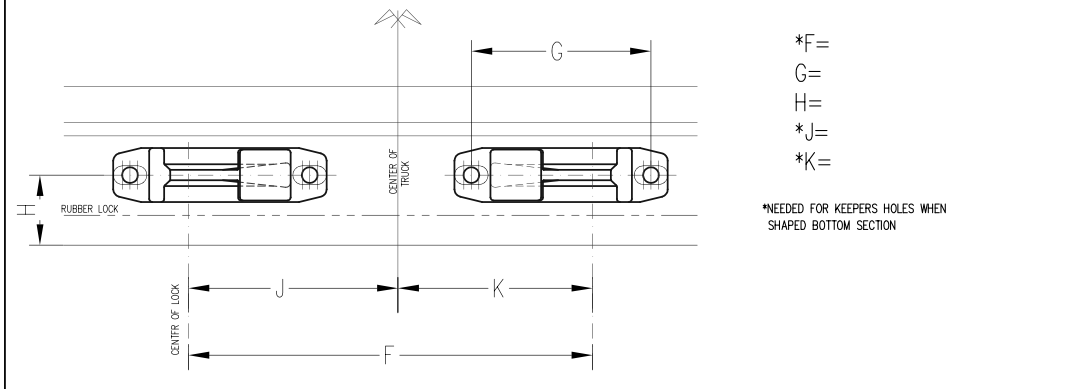

CLEARANCE LIGHTS

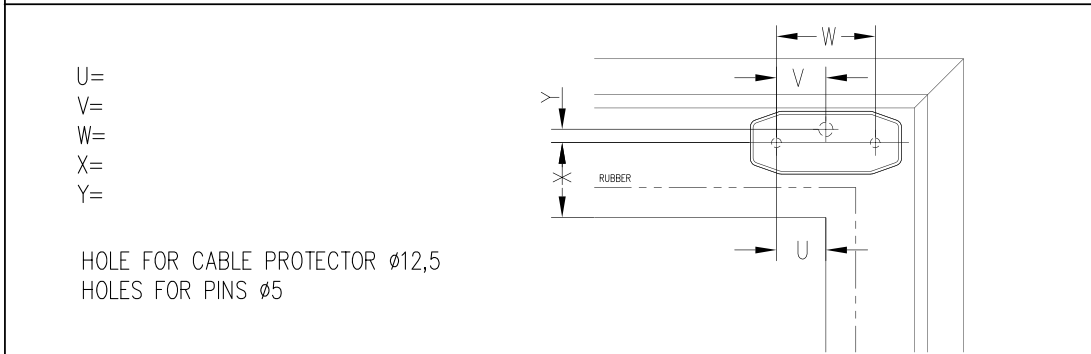

REINFORC PLATE

MATERIAL: MILD STEEL DD11 6mm

- COMPLETE FRAME REINFORCE PLATE
- REINFORCE PLATES FOR UPPER KEEPERS
- REINFORCE PLATES FOR BOTTOM KEEPERS
- REINFORCE PLATE IN CORNERS

DETAILS:
